

INSTRUCTION MANUAL
OPERATION MICROSCOPE

OMS-90

INTRODUCTION

Thank you very much for purchasing the TOPCON OMS-90 Operation Microscope.

To get the best use from the instrument, please read these instructions and place them in a convenient location for future reference.

This Instruction Manual describes the TOPCON OMS-90 Operation Microscope, including the outline, basic operations, trouble shooting, checking, maintenance and cleaning.

To get the best use from the instrument, read "DISPLAY FOR SAFE USE" and the "SAFETY CAUTIONS". Keep this manual at hand for future reference.

Precautions

- Connect the protective earth securely.
 - This instrument is not explosion-proof. Do not use any flammable and explosive gas near this instrument.
 - Do not use an electromagnetic device e.g. cellular phone near this instrument since it may cause disability of this instrument.
 - As this microscope is a precision instrument, be sure to use and store it in a place controlled under normal living temperature (10~40°C), humidity (30~75%) and air pressure (700~1060hPa) conditions, and avoid dew condensation and direct exposure to sunlight.
 - Keep the transport environment of this microscope within the following ranges: temperature(-20~50°C), humidity(30~95%) and air pressure(500~1060hPa).
 - Before starting operation, be sure to check all items and correctly connect cables following "CHECKING THE EQUIPMENT" on page 25. Make sure that the spare lamp works.
 - Make sure the power input is 280VA +10% for the power supply.
 - When moving the instrument from one location to another, retract the arms, lock the fixing knobs and then, move it slowly.
 - Do not lift the 2nd arm while "2nd arm vertical movement fixing knob" is fixed.
 - Do not force to move each part of the unit, when the fixing knob is tightened.
-



This symbol is applicable for EU member countries only.



To avoid potential negative consequences for the environment and possibly human health, this instrument should be disposed of (i) for EU member countries - in accordance with WEEE (Directive on Waste Electrical and Electronic Equipment), or (ii) for all other countries, in accordance with local disposal and recycling laws.

DISPLAY FOR SAFE USE



In order to encourage the safe use of the product and prevent any danger to the operator and others or damage to properties, important warnings are put on the products and inserted in the instruction manuals.

We suggest that everyone understand the meaning of the following displays and icons before reading the "SAFETY CAUTIONS" and text.

WARNING





DISPLAY	MEANING
 WARNING	Ignoring or disregarding this display may lead to the danger of death or serious injury.
 CAUTION	Ignoring or disregarding this display may lead to personal injury or physical damage.
<ul style="list-style-type: none">• Injury refers to cuts, bruises, burns, electric shock, etc.• Physical damage refers to extensive damage to the building and/or the equipment and furniture.	

ICONS



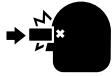

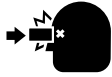

ICONS	MEANING
	This icon indicates Prohibition. Specific content is expressed with words or an icon either inserted in the icon itself or located close to the icon.
	This icon indicates Mandatory Action. Specific content is expressed with words or an icon either inserted in the icon itself or located close to the icon.
	This icon indicates Hazard Alerting (Warning). Specific content is expressed with words or an icon either inserted in the icon itself or located close to the icon.

SAFETY CAUTIONS

WARNING

Icons	Prevention item	Page
	<p>Before using the instrument, make sure that the handles, screws and knobs that have red marks are tightly secured. Falling parts may cause a serious injury.</p>	<p>15 27 28 29 34 36</p>
	<p>When loosening the 2nd arm vertical movement fixing knob , securely hold the arm end. If not the arm may suddenly move up and down and cause an injury.</p>	<p>15</p>
	<p>Do not attach/detach accessories above a patient. Falling parts may cause a serious injury.</p>	<p>15 28 29 30 34 36</p>
	<p>Before using this instrument, adjust the balance of the 2nd arm. If not, the 2nd arm may move up and down quickly and cause an injury.</p>	<p>16</p>
	<p>When using the coaxial illumination in ophthalmic applications, use the minimum illumination which allows for satisfactory observation and prevents the retina of the patient from being exposed to excessive light.</p>	<p>18</p>
	<p>To prevent overheating, replace only with the specified type of lamp.</p>	<p>22 30</p>

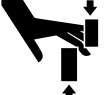
 **CAUTION**

Icons	Prevention item	Page
	To avoid electric shock, do not open the instrument. Refer all servicing to only qualified personnel.	25
	The gas spring in the 2nd arm has high pressure gas inside. Don't disassemble the gas spring or throw it into a fire. An explosion may occur and cause an injury.	25
	During and right after operation, handle the lamp house with care. The lamp house becomes hot during operation and can cause a burn.	22 30
	When the buzzer sounds, stop operation at once and turn off the power switch. The instrument may be damaged due to overheating.	20
	Do not move the 2nd arm vertically by grabbing the 2nd arm since it may cause injury.	20 27
	When inserting the lamp house unit into the 1st arm, insert it by grasping the knob carefully until the end since it may cause injury.	22
	When not in use, fasten the rotation fixing knob to fix the arm. The arm may move and cause an injury.	21

USAGE AND MAINTENANCE

USAGE

The Operation Microscope is a medical instrument and the operator must be a well-trained and experienced doctor.

USER MAINTENANCE

To maintain the safety and performance of the equipment, never attempt to do the maintenance of the parts specified herein, which should be taken care of by our service personnel. The maintenance items that can be repaired by users are the following; for details, follow the instructions.

Replacing the spare lamp:

The lamp for illumination can be replaced. For details, see page 23 of this manual.

Operating the circuit breaker:

The circuit breaker can be reset. For details, see page 23 of this manual.

ESCAPE CLAUSE

- TOPCON shall not take any responsibility for damage due to fire, earthquakes, actions by third persons and other accidents, or the negligence and misuse of the user and use under unusual conditions.
- TOPCON shall not take any responsibility for damage derived from the inability to use this equipment, such as a loss of business profit and suspension of business.
- TOPCON shall not take any responsibility for damage caused by operations other than those described in this instruction manual.

WARNING INDICATIONS AND POSITIONS

To ensure safety, this equipment provides warnings.

Correctly use the equipment following these warning instructions. If any of the following marking labels are missing, please contact us at the address stated on the back cover.

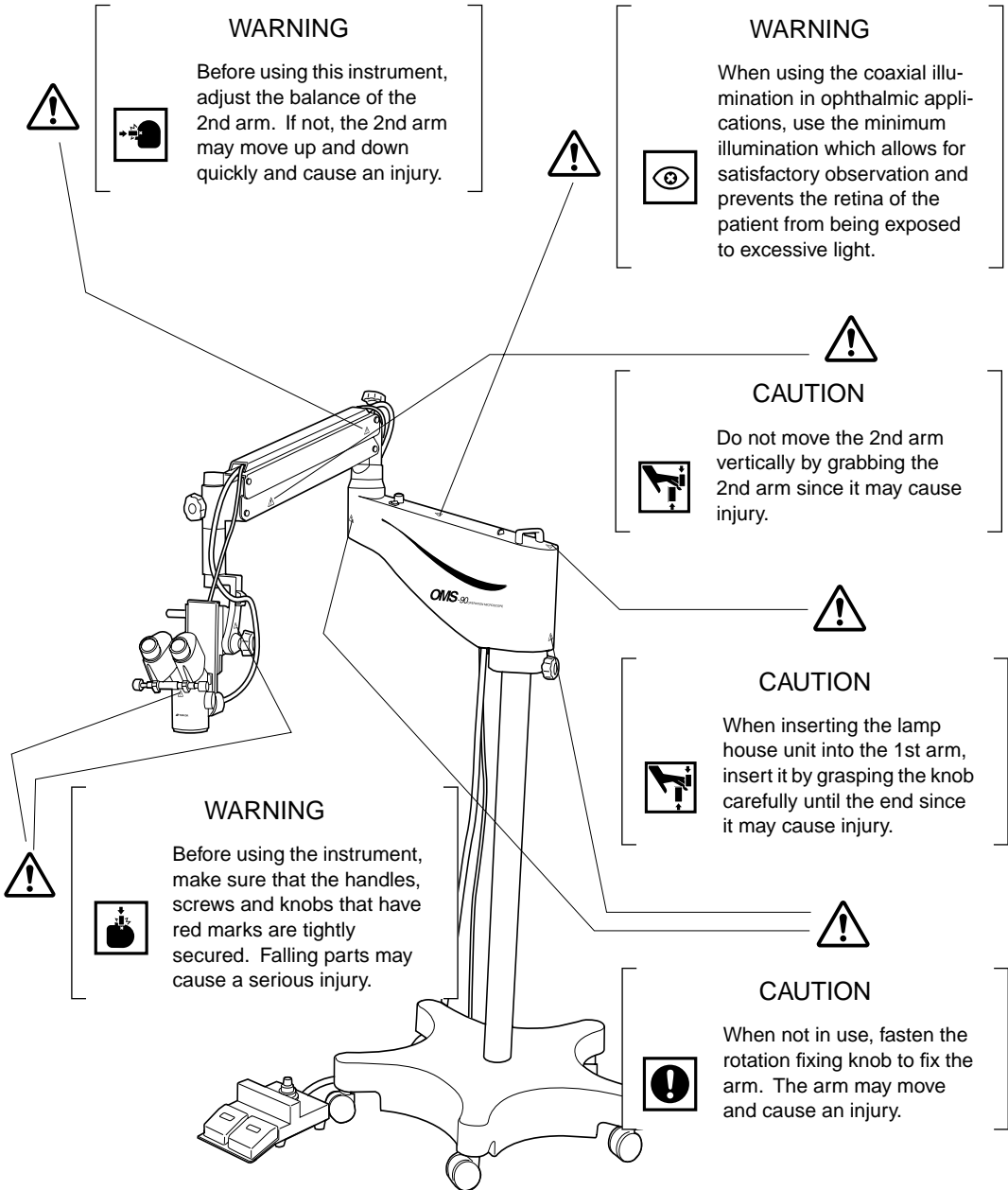

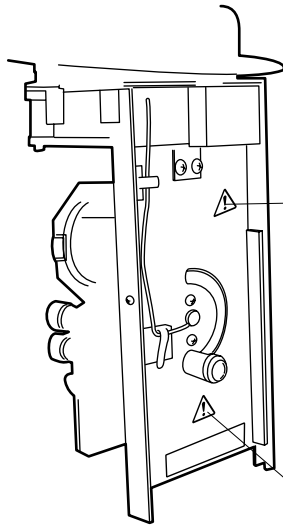

CAUTION

During and right after operation, handle the lamp house with care.



The lamp house becomes hot during operation and can cause a burn.

WARNING

To prevent overheating, replace only with the specified type of lamp.

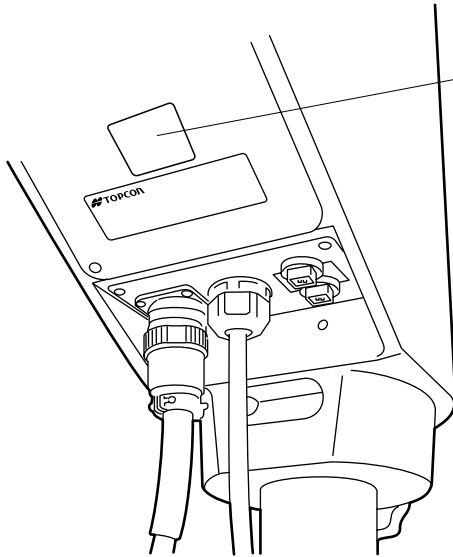

⚠ CAUTION

To avoid electric shock, do not open the instrument. Refer all servicing to only qualified personnel.

OPTIONAL ACCESSORIES

XY Translator

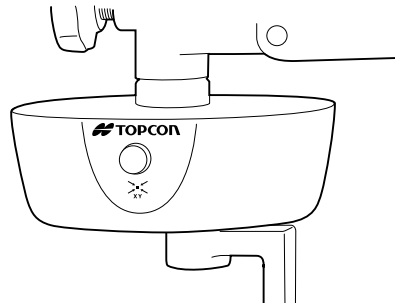

Accessory Adapter Model 2

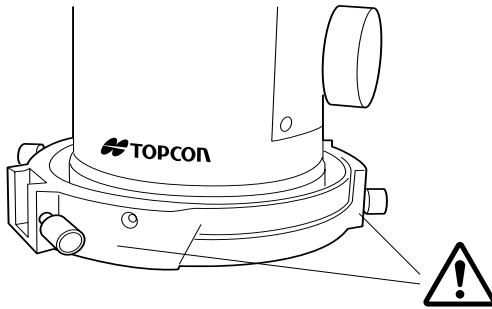

WARNING

Before using the instrument, make sure that the handles, screws and knobs that have red marks are tightly secured. Falling parts may cause a serious injury.

Assistant's Microscope

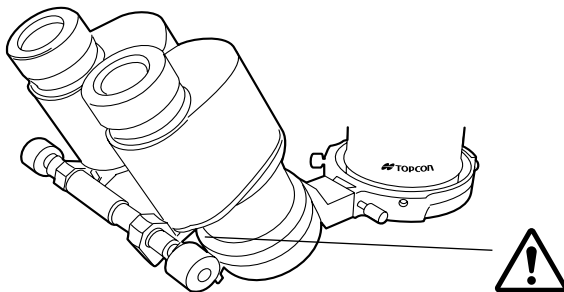

WARNING

Before using the instrument, make sure that the handles, screws and knobs that have red marks are tightly secured. Falling parts may cause a serious injury.

1/2 TV Attachment

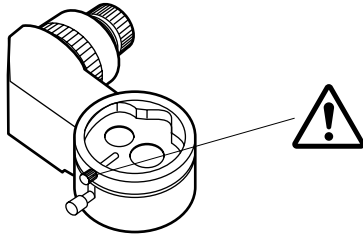

WARNING

Before using the instrument, make sure that the handles, screws and knobs that have red marks are tightly secured. Falling parts may cause a serious injury.



Beam Splitter

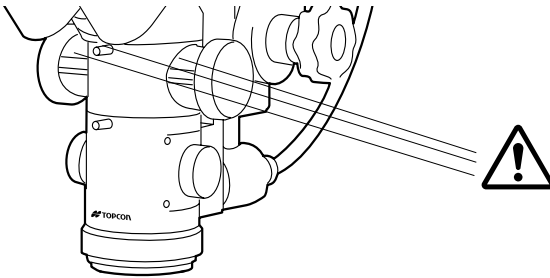

WARNING

Before using the instrument, make sure that the handles, screws and knobs that have red marks are tightly secured. Falling parts may cause a serious injury.



Oblique Illuminator

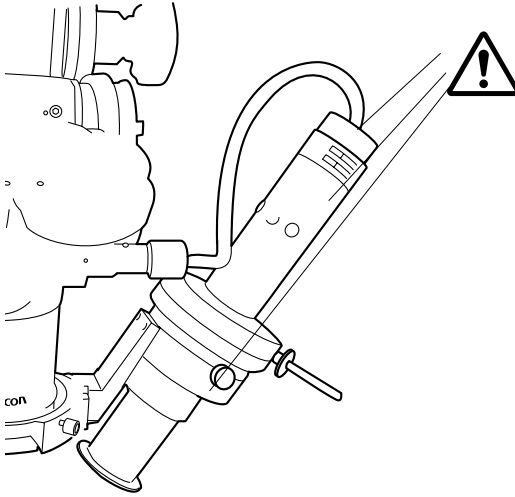

WARNING

Before using the instrument, make sure that the handles, screws and knobs that have red marks are tightly secured. Falling parts may cause a serious injury.



WARNING

To prevent overheating, replace only with the specified type of lamp.



CAUTION

During and right after operation, handle the lamp house with care. The lamp house becomes hot during operation and can cause a burn.



CONTENTS

INTRODUCTION	1
DISPLAY FOR SAFE USE	2
SAFETY CAUTIONS	3
USAGE AND MAINTENANCE	5
USER MAINTENANCE	5
ESCAPE CLAUSE	5
WARNING INDICATIONS AND POSITIONS	6
OPTIONAL ACCESSORIES	8

COMPONENTS

COMPONENT NAMES	13
STANDARD ACCESSORIES	14

PREPARATIONS BEFORE USE

SETTINGS AND ADJUSTMENTS	15
--------------------------------	----

OPERATIONS IN USE

OPERATIONS IN USE	20
-------------------------	----

AFTER USE

OPERATION AFTER USE	21
MOVING AND STORING AFTER USE	21

MAINTENANCE AND CHECK UP

MAINTENANCE	22
CHECKING THE EQUIPMENT	25
DISPOSITION	25

TROUBLE SHOOTING

TROUBLE SHOOTING GUIDE	26
------------------------------	----

OPTIONAL ACCESSORIES

XY TRANSLATOR	27
ACCESSORY ADAPTER MODEL 2	28
ASSISTANT'S MICROSCOPE	29

OBLIQUE ILLUMINATOR	30
1/2 TV ATTACHMENT	34
BEAM SPLITTER	36

SPECIFICATIONS

SPECIFICATIONS	38
CLASSIFICATION	38
ELECTROMAGNETIC COMPATIBILITY	39
CALLING FOR REPAIR	42
SYSTEM OUTLINE	43

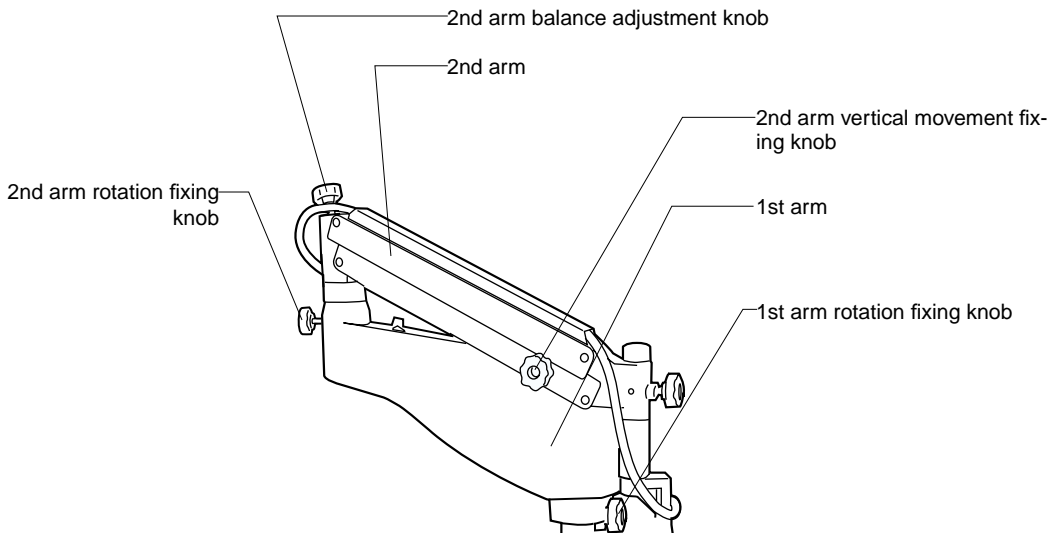
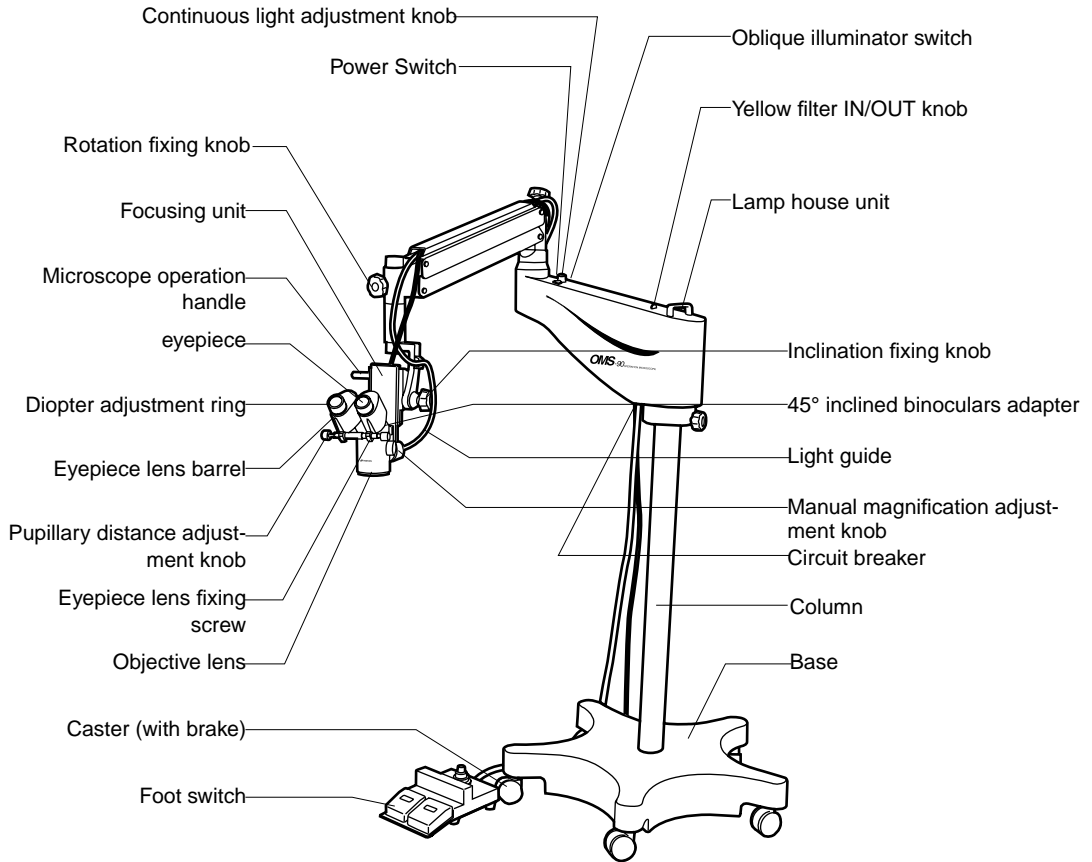

COMPONENTS

COMPONENT NAMES

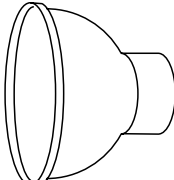

STANDARD ACCESSORIES

Make sure that the following standard accessories are complete.

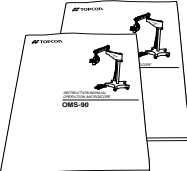
Sterilized Cap									
<table border="1"> <thead> <tr> <th>Position</th> <th>Quantity</th> </tr> </thead> <tbody> <tr> <td>Pupillary distance adjustment knob</td> <td>2</td> </tr> <tr> <td>Manual magnification adjustment knob</td> <td>2</td> </tr> <tr> <td>Inclination fixing knob</td> <td>1</td> </tr> </tbody> </table>	Position	Quantity	Pupillary distance adjustment knob	2	Manual magnification adjustment knob	2	Inclination fixing knob	1	
Position	Quantity								
Pupillary distance adjustment knob	2								
Manual magnification adjustment knob	2								
Inclination fixing knob	1								
Lamp (2)	Cover(1)								
									
Instruction manual (1), Assembly manual(1)									
									

For optional accessories, see "OPTIONAL ACCESSORIES" on page 27.

PREPARATIONS BEFORE USE

SETTINGS AND ADJUSTMENTS

 Warning	Before using the instrument, make sure that the handles, screws and knobs that have red marks are tightly secured. Falling parts may cause a serious injury.
--	--

Notice	Before using the instrument, make sure that the spare lamp is lit.
---------------	--

Notice	Before using the instrument, make sure that the circuit breaker is normal.
---------------	--

Sterilization

- The sterilized cap and the microscope operation handle according to the following.
Method:auto cleave
Condition:leave in saturated steam (134 ± 4) for 20 minutes.

Installation

- When installing this microscope, make sure there is enough space to move the arm safely during operation and check-up.
- Lock the brakeing switch on the caster after installing.

When handling accessories

 Warning	When loosening the 2nd arm vertical movement fixing knob, securely hold the arm end. If not the arm may suddenly move up and down and cause an injury.
--	--

 Warning	Do not attach/detach accessories above a patient. Falling parts may cause a serious injury.
--	---

- Before any accessory is added or removed, be sure to fasten the 2nd arm vertical movement fixing knob.
- When the microscope is not installed at the end of the 2nd arm and the vertical movement fixing knob is loosened, the 2nd arm can move up suddenly. Do not perform any operations under these conditions.



- Please refer to the instructions for each accessory at “OPTIONAL ACCESSORIES”.
- After adding or removing accessories, the arm balance adjustment will need to be reset. Make sure these adjustments and settings are done in the manner described in “Adjusting the arm balance”.

Adjusting the 2nd arm balance



Warning

Before using this instrument, adjust the balance of the 2nd arm. If not, the 2nd arm may move up and down quickly and cause an injury.

- If the upward movement of the arm is too light, the weight can be increased by turning the 2nd arm balance adjustment knob clockwise.
- If the downward movement of the arm is too light, the weight can be increased by turning the 2nd arm balance adjustment knob counterclockwise.

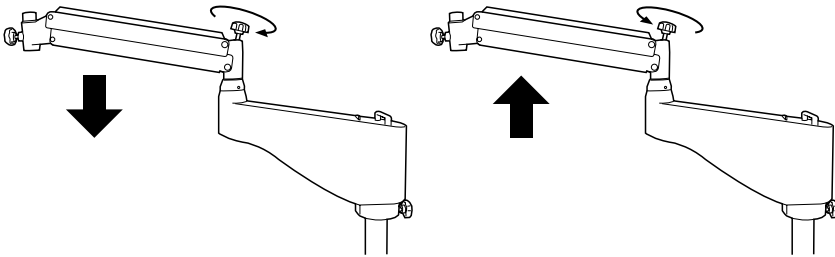

- When accessories are added or removed, the balance setting will be changed. Therefore, in every case, be sure to reset the balance following the above instructions.

Centering of the focusing unit

- 1 Insert a plug into a socket
- 2 Turn the power ON using the power switch on the panel.

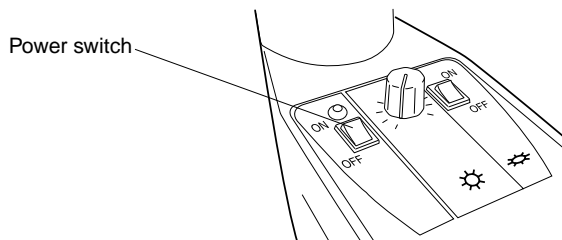

- 3 By using the foot switch, align the center mark (●) on the focusing unit with the center index (○) so that it is placed at the center of the vertical fine movement range.

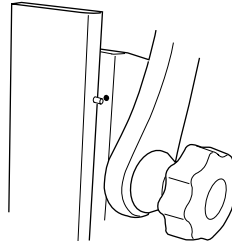

Adjusting the dioptic power

- If the operator does not need the adjustment of the dioptic power or uses glasses, etc., fit the scale of the diopter adjustment ring to “0”.
- If the operator’s dioptic power is known, set the scale of the diopter adjustment ring on the eyepiece lens to his/her dioptic power.
- If the operator’s dioptic power is not known, measure his/her dioptic power by using the eyepiece lens according to the following steps.

- 1 Turn the manual magnification adjustment knob to the maximum value.

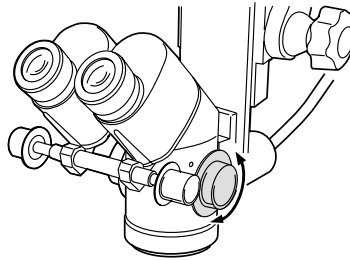

- 2 Turn each diopter adjustment ring to the maximum value in the positive direction and carefully move the microscope unit up and down with the foot switch until the object is in focus.

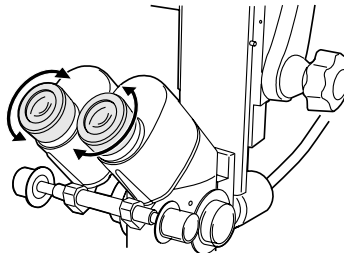

- 3 Turn the manual magnification adjustment knob to the minimum value.
- 4 While looking through the eyepiece lens for each eye, turn its diopter adjustment ring and, when the object is in focus, stop turning. Now the dioptic power is proper. The scale of the diopter adjustment ring shows the proper dioptic power.

Adjusting the pupillary distance

- Adjust the pupillary distance by looking through the eyepiece lenses and turning the pupillary distance adjustment knob so that both eyes can see correctly.

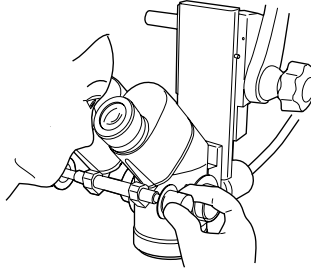

Adjusting the light intensity



Warning

When using the coaxial illumination in ophthalmic applications, use the minimum illumination which allows for satisfactory observation and prevents the retina of the patient from being exposed to excessive light.

- Set the required brightness by using the continuous light adjustment knob.

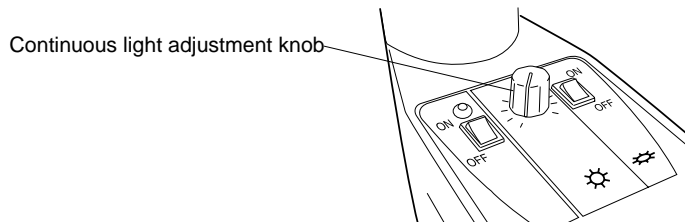

Illumination light intensity display:

- The illumination light intensity display of the OMS-90 is based on ISO10936-2 to reduce or prevent retinal injury caused by the operation microscope's illuminator. (When the radiance (LB value) weighted in the wavelength 380~700nm is $500\text{mW}/(\text{cm}^2\cdot\text{sr})$, it is regarded and displayed as 1.0.)

Using the yellow filter

- By pulling the yellow filter IN/OUT knob up, you can insert the filter.

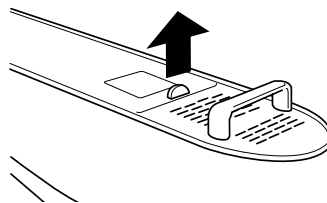

Fitting the sterilized caps and the microscope operation handle

Sterilize the caps and the handle in advance and fit them to the specified positions right before operation. The sterilized cap and the microscope operation handle positions on the microscope are illustrated below.

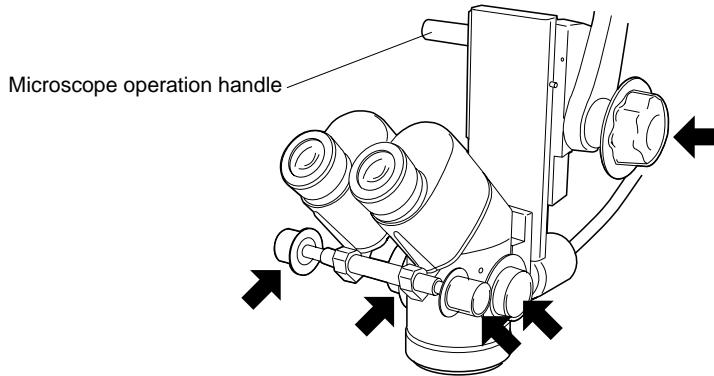

- Set the microscope operation handle by turning it to the left. Remove it by turning it to the right.

OPERATIONS IN USE

OPERATIONS IN USE



Caution

When the buzzer sounds, stop operation at once and turn off the power switch. The instrument may be damaged due to overheating.



Caution

Do not move the 2nd arm vertically by grabbing the 2nd arm since it may cause injury.

Adjusting the focus

- Coarse focusing should be done with the pupillary distance adjustment knob and fine focusing with the foot switch after setting observation magnification to maximum.

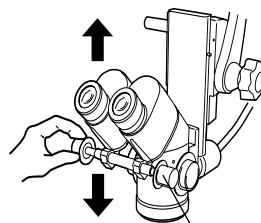

Pupillary distance adjustment knob

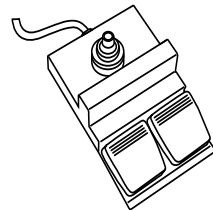

Adjusting the zoom magnification

- Turn the manual magnification adjustment knob to change the observation magnification.

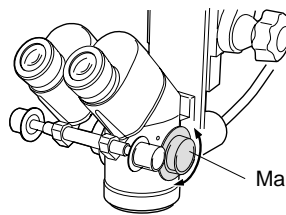

Manual magnification adjustment knob

How to use the foot switch

- Push “DOWN” and “UP” on the foot switch to adjust the fine focus of the microscope.

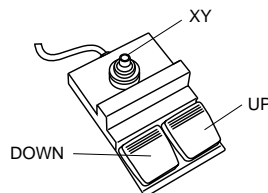

- When the XY translator (optional accessory) is installed, you can move the section to be observed by operating the XY translator lever.

AFTER USE

OPERATION AFTER USE

- 1 Turn the power off.
- 2 Pull a plug out of socket.

MOVING AND STORING AFTER USE



Caution

When not in use, fasten the rotation fixing knob to fix the arm. The arm may move and cause an injury.

- Please perform the following procedures when moving and storing this microscope.

- 1 Position the 1st and 2nd arms so as not to hinder storing.
- 2 Set the 2nd arm to the lowest limit position and lock it by tightening the 2nd arm vertical movement fixing knob.

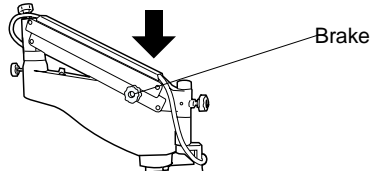
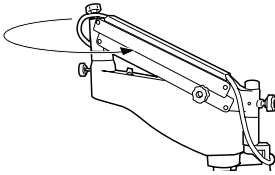

- 3 Securely lock each lock handle.

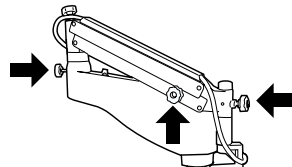

- 4 Release the brakeing switch on the caster.

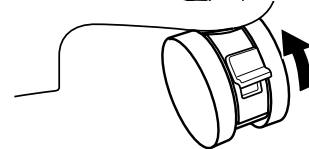

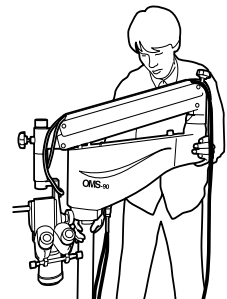
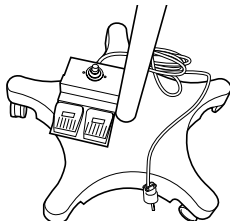

- 5 Put the foot switch on the base, hang the cord on the 1st arm and move the instrument slowly as illustrated.



MAINTENANCE AND CHECK UP

MAINTENANCE

 Warning	To prevent overheating, replace only with the specified type of lamp.
 Caution	During and right after operation, handle the lamp house with care. The lamp house becomes hot during operation and can cause a burn.
 Caution	When inserting the lamp house unit into the 1st arm, insert it by grasping the knob carefully until the end since it may cause injury.

Changing to a spare lamp

- Even if the illumination lamp burns out during operation, it can be replaced with the spare lamp simply by operating the lamp selector knob in the lamp house unit.

1 Hold and pull out the knob of the lamp house unit.

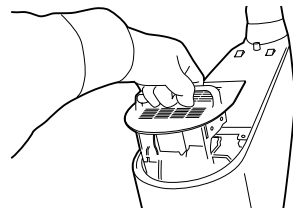

2 Hold the lamp selector knob and move it upward or downward to replace the lamp. Operate the knob until it becomes fixed by clicking.

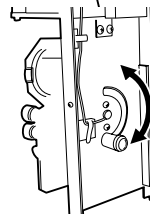

3 Insert the lamp house unit into the 1st arm as before, taking care to align it with the guide groove.

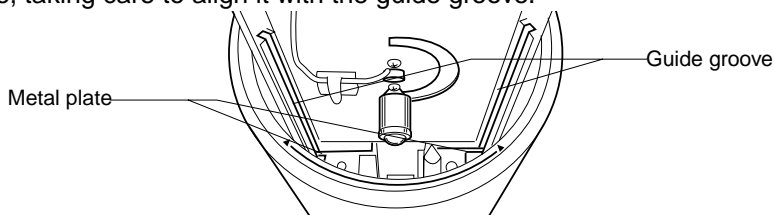

- When the lamp house unit is removed, the foot switch cannot be operated. By resetting the lamp house unit, the foot switch can be used.

Replacement of the spare lamp

- When the spare lamp is used, replace the burned lamp with a new one after operation by following the steps below:

- 1 Remove the lamp house unit in the same way as “Changing to a spare lamp”.
- 2 Remove the terminal cord by removing the 2 terminal screws connected to the burned lamp (LAMP A or LAMP B).

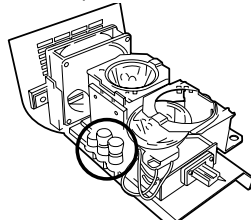

- 3 Slide the lamp sideways and pull out the lamp socket. Remove the burned out halogen lamp and replace it with a new one. When a lamp is no longer usable, the socket is also quite worn. Replace the socket with a new one.

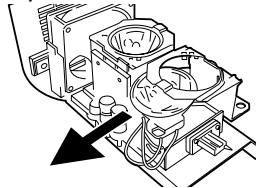

- 4 Fit a new lamp into the metal fixture so that the socket front-and-rear direction is parallel to the insertion direction.
- 5 After replacing the lamp and socket, tighten the terminal screws securely. A current of large capacity flows to this terminal. Make sure that the screws are securely tightened.
- 6 Set the lamp selector knob so that the new lamp may be “spare” and return the lamp house unit to its original position.

Operating the circuit breaker

- In case there is a problem with the power supply, the circuit breaker works automatically. When the circuit breaker works, the center button pops out. In this case, reset the button to be level with your finger.

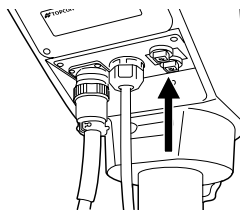

- If the circuit breaker button pops out again after resetting, there may be a problem in the main body. Contact your TOPCON dealer or TOPCON service.

Cleaning the objective lens

- When the objective lens is dirty, perform cleaning as follows.
- 1 Dampen a soft cloth with sterilizing alcohol and wipe away dust from the objective lens with it.
 - 2 Wipe the objective lens with a dry soft cloth.

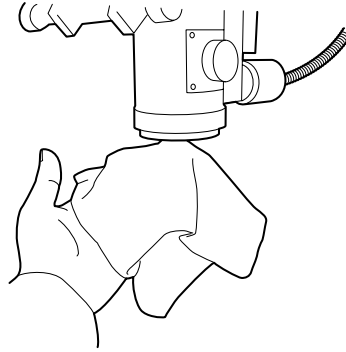

- A special coating is applied to the objective lens so that it can be cleaned simply without special methods.

Cleaning of other parts

- Clean the instrument with moist cloth.
- When you remove the stain, use diluted neutral detergent. Avoid strong detergent.

CHECKING THE EQUIPMENT



Caution

To avoid electric shock, do not open the instrument. Refer all servicing to only qualified personnel.

Daily maintenance

Make sure to check the following items before using:

- Red colored fixing knobs are important; make sure these knobs are securely tightened.
- Check the balance (movement) of the 2nd arm.
- Check that the spare lamp is usable and not burnt out.
- Make sure that the foot switch connector is connected to the root of the 1st arm.
- Make sure that the circuit breaker is normal.
- In case of a problem or abnormal operation, stop using the instrument, and check the cause by referring to the instructions in "TROUBLE SHOOTING" on page 26.

Purchase order for consumables

- When ordering consumables, state the article name, its code and quantity to your TOP-CON dealer or the TOPCON service personnel on the back cover of this manual.

Article name	Article code
Lamp unit (Halogen Lamp 12V100W, Philips Typ6834)	456254021
Socket	456258210
Sterilized cap for manual magnification adjustment knob	414701014
Sterilized cap for pupillary distance adjustment knob	455201059
Sterilized cap for inclination fixing knob	411262069
eyepiece cap	446701524

DISPOSITION



Caution

The gas spring in the 2nd arm has high pressure gas inside. Don't disassemble the gas spring or throw it into a fire. An explosion may occur and cause an injury.

- When discarding this microscope and the consumables, please contact a special waste disposer, the company you purchased it from, or the address on the back cover of this manual.

TROUBLE SHOOTING

TROUBLE SHOOTING GUIDE



If there seems to be a malfunction, first check the cause by following the steps in the check list below. If the problem cannot be resolved or the malfunction seems to be a different problem than the items listed below, contact your TOPCON dealer or TOPCON service personnel listed on the back cover of this manual.

Check List

Problem	Possible causes	Remedy	Reference page
Illumination lamp does not light.	Power cable is not connected to the power outlet.	Connect the cable to the outlet firmly.	--
	Power switch is not ON (or "I" position).	Turn power switch ON (or "I").	--
	The lamp has burned out.	Replace the lamp with a new one.	23
	The terminal screw is not tightened securely.	Tighten the terminal screw again.	23
	The circuit breaker is working.	Reset the button, circuit breaker.	23
The image becomes out-of-focus during operation.	Weight of 2nd arm vertical movement is not balanced.	Reset the 2nd arm balance adjustment knob.	16
Illumination field has a shade (unevenness) or is dark.	Bulb is not seated correctly.	Seat it correctly.	23
	A bulb other than the specified ones is used.	Replace the bulb with a specified one.	23
The buzzer sounds.	The cooling fan malfunctions.	Stop using the instrument and turn off the power switch. Then, contact your TOPCON dealer.	--

OPTIONAL ACCESSORIES

XY TRANSLATOR

 Warning	Before using the instrument, make sure that the handles, screws and knobs that have red marks are tightly secured. Falling parts may cause a serious injury.
 Caution	Do not move the 2nd arm vertically by grabbing the 2nd arm since it may cause injury.
Notice	Ask your TOPCON dealer to install the XY translator.

Features

- You can adjust the fine movement of the observation position with the foot switch.
- Press the centering button, and the microscope unit can be set to the center position.

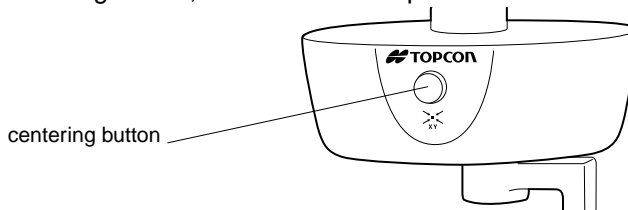

Specification

- Movement: $\pm 25\text{mm}$
- Centering: One-touch operation

Mounting

Ask your TOPCON dealer to install the XY translator.

How to use

- 1 Press the centering button to set the microscope unit to the center.
- 2 Adjust the observation section coarsely with the microscope operation handle or pupillary distance adjustment knob.
- 3 During operation, use the XY translator lever on the foot switch to adjust the observation position finely.

ACCESSORY ADAPTER MODEL 2



Warning

Before using the instrument, make sure that the handles, screws and knobs that have red marks are tightly secured. Falling parts may cause a serious injury.



Warning

Do not attach/detach accessories above a patient. Falling parts may cause a serious injury.

Features

- The assistant's microscope and oblique illuminator can be mounted and used at the same time.
- This adapter turns with the operator's optical axis as the center, making it a very convenient feature.

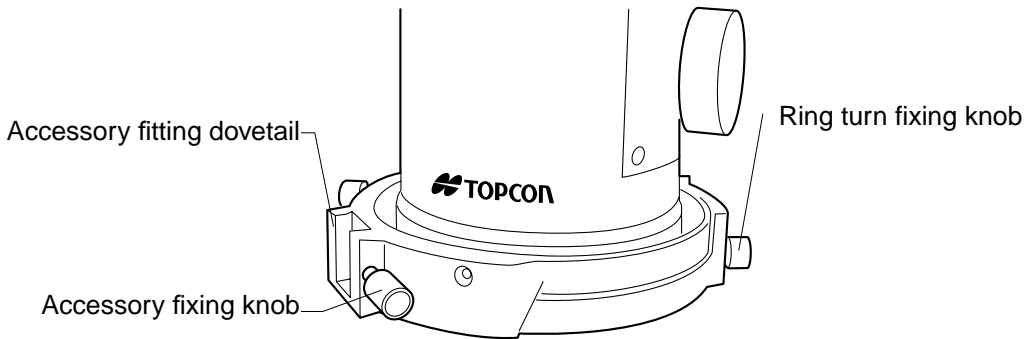

Specification

- Number of attachment accessories: 2pieces

Mounting

- 1 Remove the objective lens by turning it counterclockwise and taking care not to touch it.
- 2 Insert the Accessory Adapter Model 2 into the lens barrel and affix it with the accessory set screws by using a Phillips screwdriver.

- 3 Replace the objective lens which was removed in Step 1.

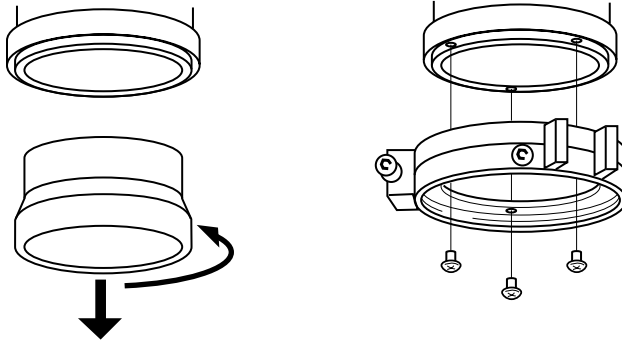

ASSISTANT'S MICROSCOPE

* Accessory Adapter Model 2 is necessary.



Warning

Before using the instrument, make sure that the handles, screws and knobs that have red marks are tightly secured. Falling parts may cause a serious injury.



Warning

Do not attach/detach accessories above a patient. Falling parts may cause a serious injury.

Features

- This microscope revolves on the optical axis of the main microscope and the assistant's microscope, making it possible to set it at the proper position.
- The joint-part mount type allows for a one-touch easy setting.

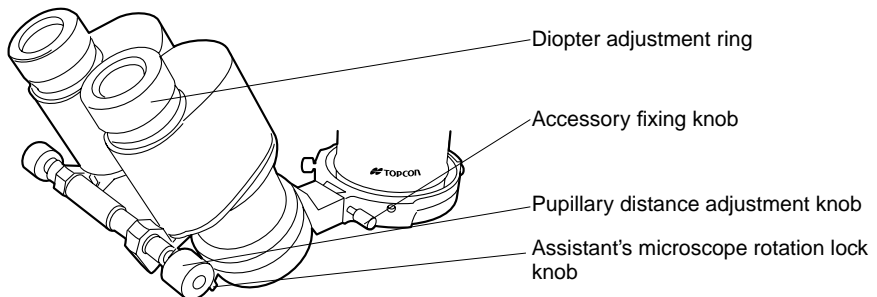

Specifications

- Magnification: 4.6 x

Mounting





- 1 Put the assistant's microscope dovetail in the accessory fitting dovetail of the accessory Adapter Model 2, then tighten it with the accessory fixing knob.
- 2 Loosen the assistant's microscope rotation lock knob and position its microscope in the proper position. Tighten the assistant's microscope rotation knob.

How to use

- 1 Make sure to adjust the dioptic power of the assistant's microscope by referring to "Adjusting the dioptic power" on page 17.
- 2 Make sure to adjust the pupillary distance of the assistant's microscope by referring to "Adjusting the pupillary distance" on page 18.
- 3 Loosen the assistant's microscope rotation lock knob and adjust microscope in the proper position.

OBLIQUE ILLUMINATOR

* Accessory Adapter Model 2 is necessary

 Warning	Before using the instrument, make sure that the handles, screws and knobs that have red marks are tightly secured. Falling parts may cause a serious injury.
 Warning	Do not attach/detach accessories above a patient. Falling parts may cause a serious injury.
 Warning	To prevent overheating, replace only with the specified type of lamp.
 Caution	During and right after operation, handle the lamp house with care. The lamp house becomes hot during operation and can cause a burn.
Notice	Ask your TOPCON dealer to install the oblique illuminator.

Features

- Illumination from the correct angle is possible since the light turns, while centering on the main microscope optical axis.

- Pull the metal fixture at the end, and slit illumination is provided.

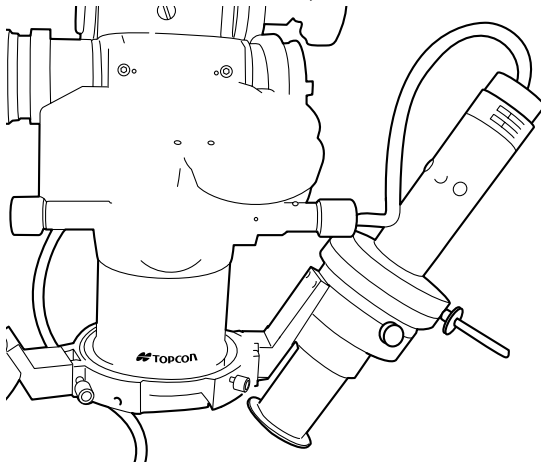

Specifications

- Uniform illumination: Lighting field $\varnothing 35\text{mm}$
- Slit illumination : Lighting field : $\varnothing 20\text{mm}$
Slit width : 0~20mm

Mounting

Ask your TOPCON dealer to install the oblique illuminator.

How to use

- Turning on the illuminator:
Set the oblique illumination ON/OFF switch to “ON” on the instrument.
- Uniform illumination:
Turn and position the slit width adjusting lever to “OPEN”. Then keep the lens barrel extender pushed in.
- Slit illumination:
Completely pull out the lens barrel extender, then turn the slit width adjusting lever to “SLIT” to provide a suitable width.
- Slit rotation:
Loosen and turn the oblique illuminator barrel rotation lock knob, then turn the lever to provide suitable angle. Then, fix the oblique illuminator barrel to tighten the oblique illuminator barrel rotation lock knob and readjust the width of the slit.

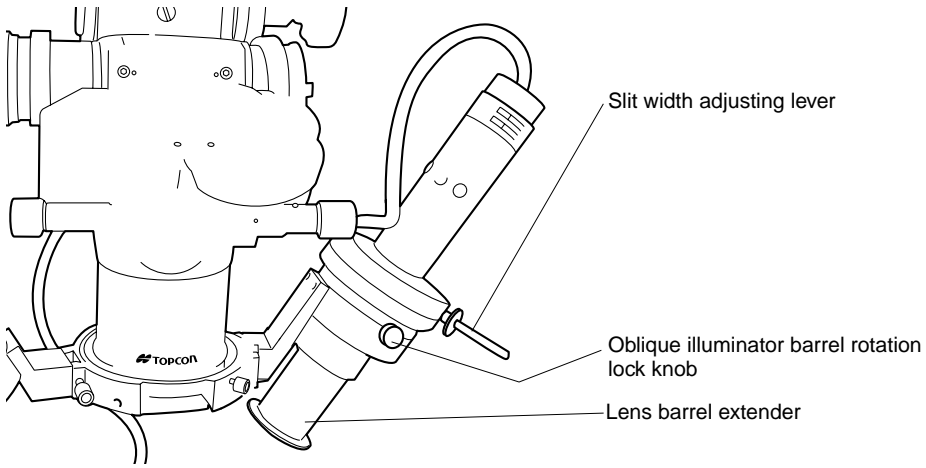

How to replace the lamp house

- 1 Loosen the lamp house lock knob and remove the lamp house from the oblique illuminator barrel.

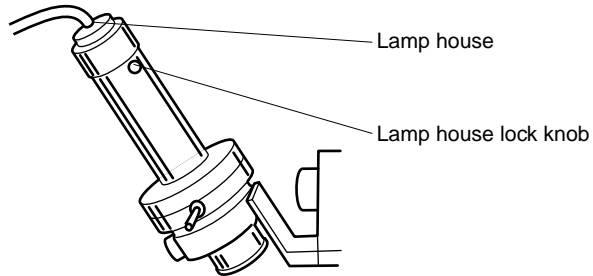

- 2 Turn the unit counterclockwise and then remove the lamp retainer ring. Loosen the cord lock knob to pull out the lamp (and push in the cord when necessary).

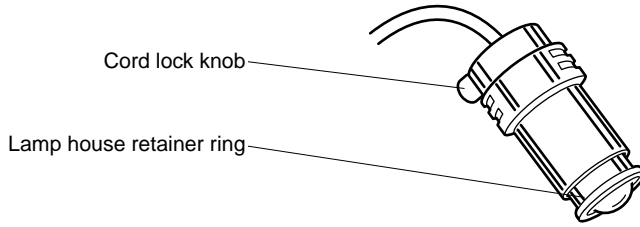

- 3 Remove the lamp with the flange from the lamp house socket (Bayonet type).

- 4 Insert the new lamp with the flange in the reverse procedure.

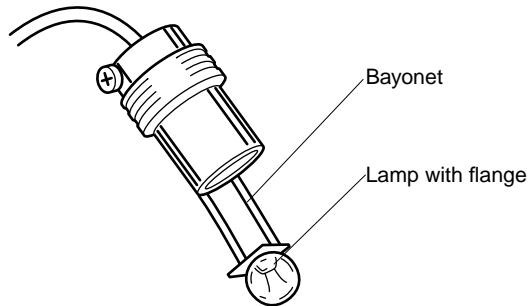

- Use care so that the flange is properly fitted.

Consumables

Article name	Article code
Lamp unit	414553031

1/2 TV ATTACHMENT



Warning

Before using the instrument, make sure that the handles, screws and knobs that have red marks are tightly secured. Falling parts may cause a serious injury.



Warning

Do not attach/detach accessories above a patient. Falling parts may cause a serious injury.

Features

Because the TV attachment shares the same optical system as the operator, the operator is able to see the same visual field in the TV monitor.

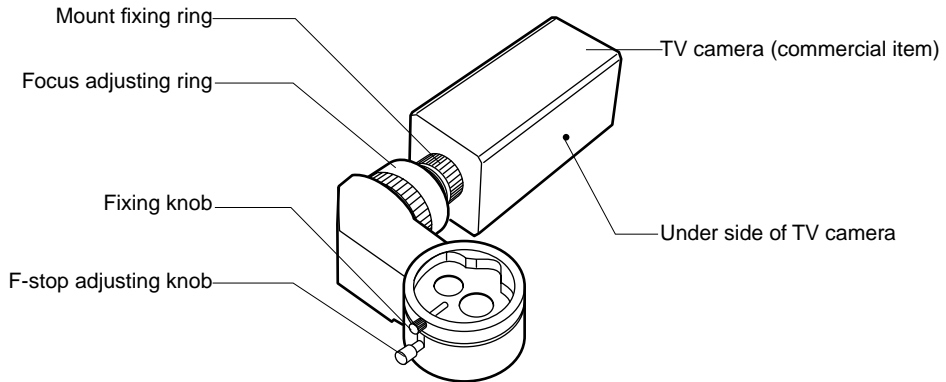

Specifications

- Beam splitter division ratio: Operator side: 80%, TV side: 20%
- TV camera mount: C mount
- Imaging size: 1/2 Type
- Adjustable focus
- Operator's visual field and TV visual field

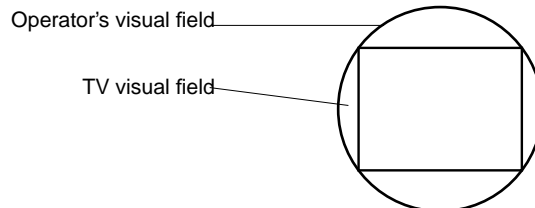

Mounting



- Install the TV camera onto the TV attachment before mounting the TV attachment to the main microscope.

- 1 Make sure that the mount fixing ring is slid toward the opposite side of the TV camera.
- 2 Secure the TV camera against the mount fixing ring. Then loosen the TV camera and set it in the proper position. Secure the mount fixing ring to affix the TV camera.
- 3 Hold the eyepiece unit and loosen the fixing knob, then remove the eyepiece unit.
- 4 Insert a pin of the microscope head into the groove of the TV attachment. Then tighten it with the fixing knob.
- 5 Insert a pin of the TV attachment into the groove of the eyepiece unit. Then tighten it with the fixing knob.

How to use

- 1 When using the TV camera, make sure to adjust the dioptic power of the main microscope by referring to “Adjusting the dioptic power” on page 17.
- 2 Make sure to adjust the focus of the image with the focus adjusting ring.
- 3 If necessary, adjust the brightness of the image by operating the diaphragm with the F-stop adjusting knob.
- 4 For TV camera operations, follow the TV camera instruction manual.

BEAM SPLITTER



Warning

Before using the instrument, make sure that the handles, screws and knobs that have red marks are tightly secured. Falling parts may cause a serious injury.



Warning

Do not attach/detach accessories above a patient. Falling parts may cause a serious injury.

Features

This is a beam splitter fixed type.

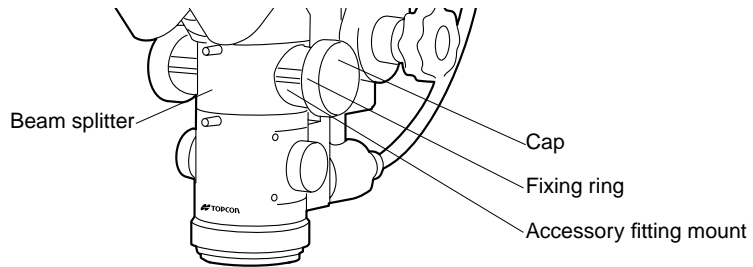

Specifications

- Division ratio:
Operator side: 50%, Accessory side: 50% or
Operator side: 80%, Accessory side: 20%

Mounting

- 1 Loosen the binoculars/beam splitter fixing screw, and remove the 45° inclined binocular's adapter and eyepiece from the lens barrel.

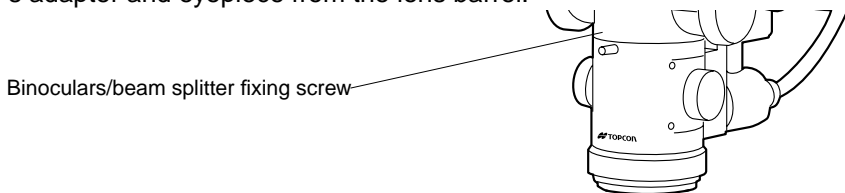

- 2 Place the beam splitter over the lens barrel, matching the beam splitter grooves with lens barrel pin and fasten it in place with the binoculars/beam splitter fixing screw.

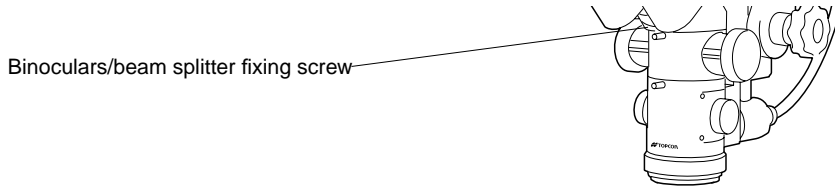

- 3 Install the 45° inclined binoculars adapter and eyepiece over the beam splitter, in the same order that they were removed.

How to use

- 1 Loosen the fixing ring and remove the cap from the accessory fitting mount.
- 2 Insert the accessory to accessory fitting mount. Then, fix the accessory to tighten the fixing ring.

SPECIFICATIONS

SPECIFICATIONS

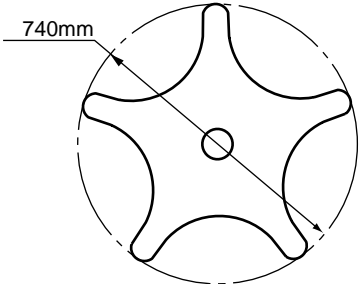
Type	Galileo type
Magnification change type	Drum type with 5 changes
Eyepieces	12.5x
Objective lens	f=200mm
Display magnification (x)	0.4 , 0.6 , 1 , 1.6 , 2.5
Total magnification (x)	3.4 , 5.3 , 8.5 , 13.6 , 21.2
Arm length	1st arm:400mm 2nd arm:560mm
Arm rotation angle	1st arm:360° 2nd arm:300°
Power supply/voltage	AC100-120V~,220-240V~ 50/60Hz
Power consumption	280VA
Base section	<p>ø740mm</p> 

CLASSIFICATION

- The type of protection against electric shock: class I equipment
- The degree of protection against harmful ingress of water: IPX0 (main body), IPX8 (foot switch)
- The mode of operation: continuous operation

ELECTROMAGNETIC COMPATIBILITY

This instrument complies with IEC60601-1-2:2001

- a) MEDICAL ELECTRICAL EQUIPMENT needs special precautions regarding EMC and needs to be installed and put into service according to the EMC information provided in the ACCOMPANYING DOCUMENTS.
- b) Portable and mobile RF communications equipment can affect MEDICAL ELECTRICAL EQUIPMENT.
- c) The use of ACCESSORIES, transducers and cables other than those specified, with the exception of transducers and cables sold by the manufacturer of the EQUIPMENT or SYSTEM as replacement parts for internal components, may result in increased EMISSIONS or decreased IMMUNITY of the EQUIPMENT or SYSTEM.
- d) The EQUIPMENT or SYSTEM should not be used adjacent to or stacked with other equipment. IF adjacent or stacked use is necessary, the EQUIPMENT or SYSTEM should be observed to verify normal operation in the configuration in which it will be used.
- e) The use of the ACCESSORY, transducer or cable with EQUIPMENT and SYSTEMS other than those specified may result in increased EMISSION or decreased IMMUNITY of the EQUIPMENT or SYSTEM.

X-Y Translator 457459001 MS-XY03
 Oblique Illuminator 414830011 SHASHO.f200

Guidance and manufacturer's declaration - electromagnetic emissions		
The OMS-90 is intended for use in the electromagnetic environment specified below. The customer or the user of the OMS-90 should assure that it is used in such an environment.		
Emissions test	Compliance	Electromagnetic environment - guidance
RF emissions CISPR 11	Group 1	The OMS-90 uses RF energy only for its internal function. Therefore, its RF emissions are very low and are not likely to cause any interference in nearby electronic equipment. The OMS-90 is suitable for use in all establishments other than domestic and those directly connected to the public low-voltage power supply network that supplies buildings used for domestic purposes.
RF emissions CISPR 11	Class A	
Harmonic emissions IEC61000-3-2	Class A	
Voltage fluctuations/ flicker emissions IEC61000-3-3	Complies	

Guidance and manufacturer's declaration - electromagnetic immunity

The OMS-90 is intended for use in the electromagnetic environment specified below.
The customer or the user of the OMS-90 should assure that it is used in such an environment.

Immunity test	IEC 60601 test level	Compliance level	Electromagnetic environment - guidance
Electrostatic discharge(ESD) IEC 61000-4-2	± 6 kV contact ± 8 kV air	± 6 kV contact ± 8 kV air	Floors should be wood, concrete or ceramic tile. If floors are covered with synthetic material, the relative humidity should be at least 30%.
Electrical fast transient/burst IEC 61000-4-4	± 2 kV for power supply lines ± 1 kV for input/output lines	± 2 kV for power supply lines ± 1 kV for input/output lines	Mains power quality should be that of a typical commercial or hospital environment.
Surge IEC 61000-4-5	± 1 kV differential mode ± 2 kV common mode	± 1 kV differential mode ± 2 kV common mode	Mains power quality should be that of a typical commercial or hospital environment.
Voltage dips, short interruptions and Voltage variations on power supply input lines IEC 61000-4-11	<5% U_t (>95% dip in U_t) for 0, 5 cycle 40% U_t (60% dip in U_t) for 5 cycles 70% U_t (30% dip in U_t) for 25 cycles <5% U_t (>95% dip in U_t) for 5 sec	<5% U_t (>95% dip in U_t) for 0, 5 cycle 40% U_t (60% dip in U_t) for 5 cycles 70% U_t (30% dip in U_t) for 25 cycles <5% U_t (>95% dip in U_t) for 5 sec	Mains power quality should be that of a typical commercial or hospital environment. If the user or the OMS-90 requires continued operation during power mains interruptions, it is recommended that the OMS-90 be powered from an uninterruptible power supply or battery.
Power frequency (50/60 Hz) magnetic field IEC 61000-4-8	3 A/m	3 A/m	Power frequency magnetic fields should be at levels characteristic of a typical location in a typical commercial or hospital environment.
NOTE U_t is the a.c. mains voltage prior to application of the test level.			

Guidance and manufacturer's declaration - electromagnetic immunity

The OMS-90 is intended for use in the electromagnetic environment specified below.
The customer or the user of the OMS-90 should assure that it is used in such an environment.

Immunity test	IEC 60601 test level	Compliance level	Electromagnetic environment - guidance
<p>Conducted RF IEC 61000-4-6</p> <p>Radiated RF IEC 61000-4-3</p>	<p>3 Vrms 150kHz to 80MHz</p> <p>3 V/m 80MHz to 2, 5GHz</p>	<p>3 V</p> <p>3 V/m</p>	<p>Portable and mobile RF communications equipment should be used no closer to any part of the OMS-90, including cables, than the recommended separation distance calculated from the equation applicable to the frequency of the transmitter.</p> <p>Recommended separation distance</p> $d = 1.2 \sqrt{P}$ $d = 1.2 \sqrt{P} \quad 80\text{MHz to } 800\text{MHz}$ $d = 2.3 \sqrt{P} \quad 800\text{MHz to } 2, 5\text{GHz}$ <p>where P is the maximum output power rating of the transmitter in watts (W) according to the transmitter manufacturer and d is the recommended separation distance in meters (m).</p> <p>Field strengths from fixed RF transmitters, as determined by an electromagnetic site survey, ^a should be less than the compliance level in each frequency range. ^b</p> <p>Interference may occur in the vicinity of equipment marked with the following symbol:</p> <div style="text-align: center;">  </div>

NOTE 1 At 80 MHz and 800 MHz, the higher frequency range applies.
NOTE 2 These guidelines may not apply in all situations. Electromagnetic propagation is affected by absorption and reflection from structures, objects and people.

^a Field strengths from fixed transmitters, such as base stations for radio (cellular/cordless) telephones and land mobile radios, amateur radio, AM and FM radio broadcast and TV broadcast cannot be predicted theoretically with accuracy. To assess the electromagnetic environment due to fixed RF transmitters, an electromagnetic site survey should be considered. If the measured field strength in the location in which the OMS-90 is used exceeds the applicable RF compliance level above, the OMS-90 should be observed to verify normal operation. If abnormal performance is observed, additional measures may be necessary, such as reorienting or relocating the OMS-90.

^b Over the frequency range 150 kHz to 80 MHz, field strengths should be less than 3 V/m.

**Recommended separation distance between
portable and mobile RF communications equipment and the OMS-90**

The OMS-90 is intended for use in an electromagnetic environment in which radiated RF disturbances are controlled. The customer or the user of the OMS-90 can help prevent electromagnetic interference by maintaining a minimum distance between portable and mobile RF communications equipment (transmitters) and the OMS-90 as recommended below, according to the maximum output power of the communications equipment.

Rated maximum output power of transmitter W	Separation distance according to frequency of transmitter		
	150kHz to 80MHz $d = 1.2 \sqrt{P}$	80MHz to 800MHz $d = 1.2 \sqrt{P}$	800MHz to 2,5GHz $d = 2.3 \sqrt{P}$
0, 01	0, 12	0, 12	0, 23
0, 1	0, 38	0, 38	0, 73
1	1.2	1.2	2.3
10	3.8	3.8	7.3
100	12	12	23

For transmitters rated at a maximum output power not listed above, the recommended separation distance d in metres (m) can be estimated using the equation applicable to the frequency of the transmitter, where P is the maximum output power rating of the transmitter in watts (W) according to the transmitter manufacturer.

NOTE 1 At 80 MHz and 800 MHz, the separation distance for the higher frequency range applies.
NOTE 2 These guidelines may not apply in all situations. Electromagnetic propagation is affected by absorption and reflection from structures, objects and people.

CALLING FOR REPAIR

For questions about this operation microscope, Please specify the following.

- Model name: OMS-90
- Serial No.: Marked on the rating nameplate attached to the bottom of the 1st arm.
- Period of use: Please inform us of the date of purchase.
- Defective condition: Please tell us the condition in detail.

SYSTEM OUTLINE

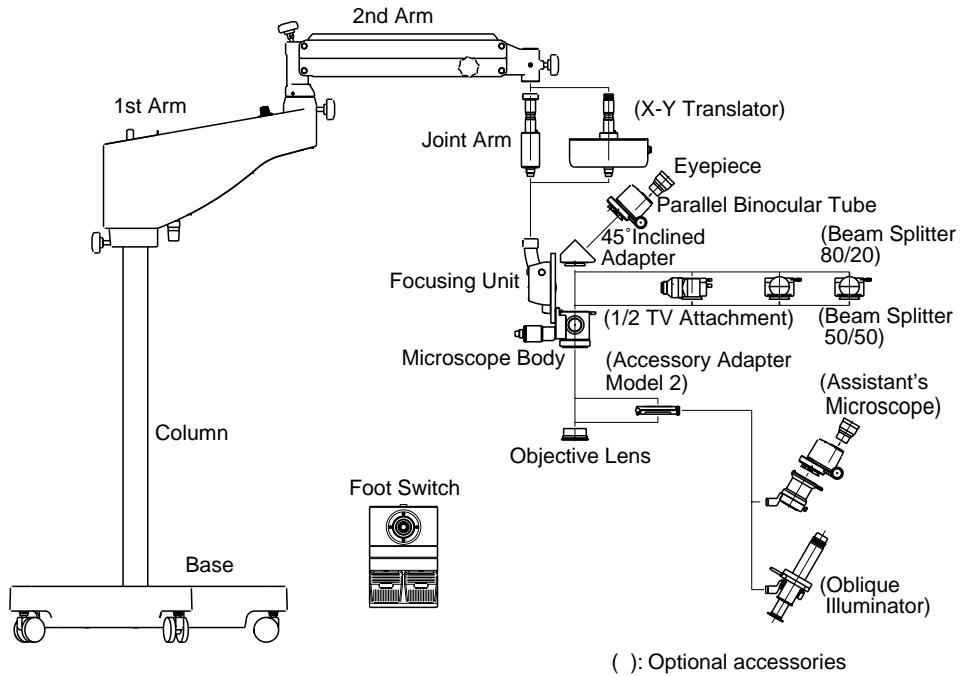

- * The maximum loading weight of 2nd Arm is 11kg. Please make sure that total weight of equipped optional accessories does not exceed 11kg.
- * Please note that weight of CCD camera listed below is for your reference. Please check the actual weight.

w/XY-Translator		The pattern of accessories attachment										
Item	Weight[kg] (Ref. value)	Assistant's Microscope	Oblique Illuminator	TL5A +CCD camera	BS +CCD camera	Assistant's Microscope +Oblique Illuminator	Assistant's Microscope +TL5A +CCD camera	Assistant's Microscope +BS +CCD camera	Oblique Illuminator +TL5A +CCD camera	Oblique Illuminator +BS +CCD camera	Assistant's Microscope +Oblique Illuminator +TL5A +CCD camera	Assistant's Microscope +Oblique Illuminator +BS +CCD camera
Standard Composition(w/XY)	4.23	○	○	○	○	○	○	○	○	○	○	○
XY-Translator	3.20	○	○	○	○	○	○	○	○	○	○	○
Assistant's Microscope	1.48	○				○	○	○			○	○
Beam Splitter(BS)	0.45							○		○		○
1/2 TV Attachment(TL5A)	0.60			○			○		○		○	
Accessory Adapter Model 2	0.25	○	○			○	○	○		○	○	○
Oblique Illuminator	0.86		○			○		○	○	○	○	○
Commercial CCD camera	(0.80)			○	○		○	○	○	○	○	○
Commercial Relay Lens	(0.30)				○			○		○		○
The maximum loading weight of 2nd arm		○	○	○	○	○	○	○	○	○	○	○

wo/XY-Translator		The pattern of accessories attachment										
Item	Weight[kg] (Ref. value)	Assistant's Microscope	Oblique Illuminator	TL5A +CCD camera	BS +CCD camera	Assistant's Microscope +Oblique Illuminator	Assistant's Microscope +TL5A +CCD camera	Assistant's Microscope +BS +CCD camera	Oblique Illuminator +TL5A +CCD camera	Oblique Illuminator +BS +CCD camera	Assistant's Microscope +Oblique Illuminator +TL5A +CCD camera	Assistant's Microscope +Oblique Illuminator +BS +CCD camera
Standard Composition(wo/XY)	5.63	○	○	○	○	○	○	○	○	○	○	○
XY-Translator	3.20											
Assistant's Microscope	1.48	○				○	○	○			○	○
Beam Splitter(BS)	0.45				○			○		○		○
1/2 TV Attachment(TL5A)	0.60			○			○		○		○	
Accessory Adapter Model 2	0.25	○	○			○	○	○		○	○	○
Oblique Illuminator	0.86		○			○		○	○	○	○	○
Commercial CCD camera	(0.80)			○	○		○	○	○	○	○	○
Commercial Relay Lens	(0.30)				○			○		○		○
The maximum loading weight of 2nd arm		○	○	○	○	○	○	○	○	○	○	○

For questions about this operation microscope, please specify the following.

- Model name: OMS-90
- Serial No.: Marked on the rating nameplate attached to the bottom of the 1st arm.
- Period of use: Please inform us of the date of purchase.
- Defective condition: Please tell us the condition in detail.

OPERATION MICROSCOPE OMS-90

INSTRUCTION MANUAL

Version of 2005 (2005.8-100TH3)

Date of issue: 29, August, 2005

Published by TOPCON CORPORATION

75-1 Hasunuma-cho, Itabashi-ku, Tokyo, 174-8580 Japan.

OPERATION MICROSCOPE

OMS-90

TOPCON MEDICAL SYSTEMS, INC.

37 West Century Road, Paramus, New Jersey 07652, U.S.A. Phone: 201-261-9450 Fax: 201-387-2710 www.topcon.com

TOPCON CANADA INC.

110 Provencher Avenue, Boisbriand, QC J7G 1N1 CANADA Phone: 450-430-7771 Fax: 450-430-6457 www.topcon.ca

TOPCON EUROPE B.V.

(European Representative)

Essebaan 11, 2908 LJ Capelle a/d IJssel, THE NETHERLANDS Phone: 010-4585077 Fax: 010-4585045 www.topconeuropa.com

TOPCON EUROPE MEDICAL B.V.

(European Sole Sales Company)

Essebaan 11, 2908 LJ Capelle a/d IJssel, THE NETHERLANDS Phone: 010-4585077 Fax: 010-2844940 www.topconeuropa.com

ITALY OFFICE: Via Dell' Industria n.60, 20037 Paderno Dugnano, (Milano), ITALY Phone: 02-61-25-583 E-mail: info.topconitaly@tiscali.it www.topcon.it

TOPCON DEUTSCHLAND G.m.b.H.

Giesserallee 31-33 D-47877 Willich GERMANY Phone: 02154-8850 Fax: 02154-885111 www.topcon.de Med@topcon.de

TOPCON ESPAÑA S.A.

HEAD OFFICE: Frederic Mompou 5, ED. Euro 3, 08960, Sant Just Desvern Barcelona, SPAIN Phone: 93-4734057 Fax: 93-4733932 www.topconesp.com

MADRID OFFICE: Avenida Burgos, 16E, 1° 28036, Madrid, SPAIN Phone: 91-302-4129 Fax: 91-383-3890

TOPCON S.A.R.L.

89, rue de Paris 92585 Clichy, Cedex, FRANCE Phone: 01-4106-9494 Fax: 01-4739-0251

TOPCON SCANDINAVIA A.B.

Neogatan 2 S-43151 Molndal, SWEDEN Phone: 031-7109200 Fax: 031-7109249 info@topcon.se

TOPCON (GREAT BRITAIN) LTD.

Topcon House, Kennet Side, Bone Lane, Newbury, Berkshire RG14 5PX United Kingdom Phone: 01635-551120 Fax: 01635-551170

TOPCON SOUTH ASIA PTE.LTD.

Blk 192 Pandan Loop, #07-01 Pantech Industrial Complex, SINGAPORE 128381 Phone: 62780222 Fax: 62733540 www.topcon.com.sg

TOPCON INSTRUMENTS (MALAYSIA) SDN.BHD.

Excella Business Park Block C, 1st Floor, Jalan Ampang Putra, Taman Ampang Hillir, 55100 Kuala Lumpur, MALAYSIA Phone: 03-42701192 Fax: 03-42704508

TOPCON INSTRUMENTS (THAILAND) CO.,LTD.

77/162 Sinn Sathorn Tower, 37th Fl., Krungdhonburi Rd., Klongtong Sai, Klongsarn, Bangkok 10600, THAILAND Phone: 440-1152~7 Fax: 440-1158

TOPCON AUSTRALIA PTY.LTD.

Unit 18, 4 Avenue of Americas Newington NSW 2127 AUSTRALIA Phone: 02-8748-8777 Fax: 02-9647-2926 www.topcon.com.au

TOPCON KOREA CORPORATION

2F Yooseoung Bldg., 1595-3, Seocho-Dong, Seocho-Gu, Seoul, 137-876 KOREA Phone: 02-2055-0321 Fax: 02-2055-0319 www.topcon.co.kr

TOPCON OPTICAL (H.K.) LTD.

2/F., Meeco Industrial Bldg., No.53-55 Au Pui Wan Street, Fo Tan Road, Shatin, N.T., Hong Kong Phone: 2690-1328 Fax: 2690-2221 E-mail: sales@topcon.com.hk

TOPCON CORPORATION BEIJING OFFICE

1070 Poly Plaza Building, 14 Dongzhimen Nandajie Dongcheng District, Beijing, 100027, CHINA Phone: 10-6501-4191 Fax: 10-6501-4190

TOPCON CORPORATION BEIRUT OFFICE

P.O.Box 70-1002 Antelias, BEIRUT-LEBANON Phone: 961-4-523525/523526 Fax: 961-4-521119

TOPCON CORPORATION DUBAI OFFICE

C/O Atlas Medical FZCO., P.O.Box 54304, C-25, Dubai Airport Free Zone, UAE Phone: 971-4-2995900 Fax: 971-4-2995901

TOPCON CORPORATION

75-1 Hasunuma-cho, Itabashi-ku, Tokyo, 174-8580 Japan.

Phone: 3-3558-2520 Fax: 3-3960-4214 www.topcon.co.jp